PLATE



21643



21642

WARNING! When installing and whenever acting on the appliance, ensure that the power supply has been switched off.

For the installation of the spare-part, it is necessary to consult a qualified electrician.

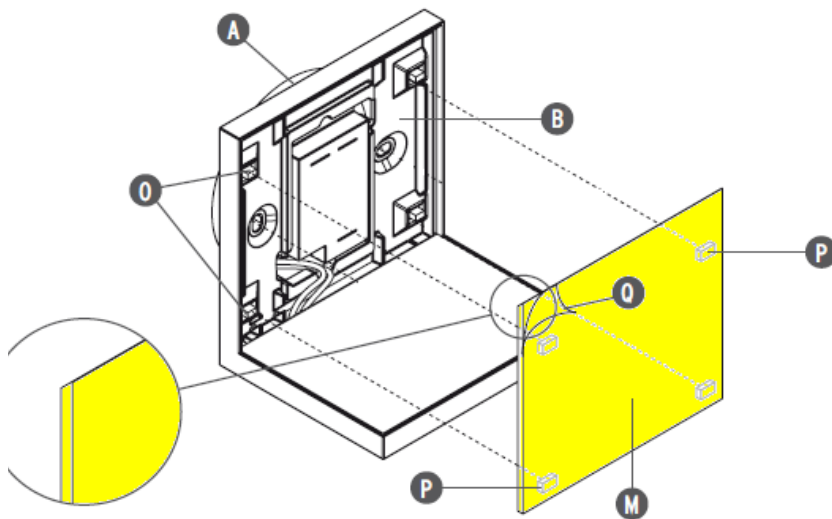

Assemble the plate (M) onto the body (B) placing the metal plugs (O) in line with the magnets (P), ensuring to observe the right orientation (the rounded-off side of the plate must be positioned upwards as shown in the image). Remove the plastic wrap (Q) from the plate (M).